

TABURETES PLEGABLES / FOLDABLE STOOLS / MARCHEPIEDS PLIABLES / TAMBORETES DOBRÁVELS

K-FOLD Taburete plegable
Folding stool
Marchepied pliant
Tamborete dobrável

- ES** Construido con perfiles de extrusión de aluminio de alta fiabilidad. Escalones de 23 cm de huella y 37 cm de anchura con relieves antideslizantes. Tapafinales de PVC antideslizantes. Barandilla de seguridad y ruedas de ø80 mm, según referencia. Diseñado para soportar 150 kg según Norma EN 14183.
- EN** Constructed with extruded aluminum profiles. Steps of 23 cm footprint and 37 cm wide with anti-slip reliefs. Anti-slip PVC end caps. Safety railing and wheels of ø80 mm according to reference. Designed to support 150 kg according to Standard EN 14183.
- FR** Construit avec des profils en aluminium extrudé. Marches de 23 cm d'empreinte et de 37 cm de large avec reliefs antidérapants. Patins en PVC antidérapants. Rampe de sécurité et roues de ø80 mm selon référence. Conçu pour supporter 150 kg selon la Norme EN 14183.
- PT** Construído com perfis de alumínio de extrusão. Degraus de 23 cm de pegada e 37 cm largo com relevos antiderrapantes. Coberturas antiderrapantes em PVC. Corrimão de segurança e rodas de ø80 mm de acordo com a referência. Projetado para suportar 150 kg de acordo com a Norma EN 14183.



REF 26 645 103

1 Sistema de bloqueo de seguridad.
Safety locking system.
Système de verrouillage de sécurité.
Sistema de bloqueio de segurança.

2 Rueda de desplazamiento de ø80 mm.
Scroll wheel of ø80 mm.
Roue de déplacement de ø80 mm.
Roda de rolagem de ø80 mm.



3 Barandilla de seguridad.
Safety railing.
Rampe de sécurité.
Corrimão de segurança.

REF	Escalones Steps Marches Degraus	Perfiles mm Profiles mm Profils mm Perfis mm							kg
26 645 202	2	33x20 (2) / 64x25	0,84	0,46	0,53	2,46	0,08	0,46	4,2
26 645 203	3	33x20 (2) / 64x25	1,17	0,69	0,77	2,69	0,08	0,46	6,7
26 645 204	4	33x20 (2) / 64x25	1,50	0,92	1,03	2,92	0,08	0,46	8,4
26 645 103*	3	33x20 (2) / 64x25	1,17	0,69	0,85	2,69	0,17	0,46	7,2
26 645 104*	4	33x20 (2) / 64x25	1,50	0,92	1,10	2,92	0,17	0,46	8,9

EN 14183

150 kg



TABURETES PLEGABLES / FOLDABLE STOOLS / MARCHEPIEDS PLIABLES / TAMBORETES DOBRÁVELS

K-FOLD Taburete plegable
Folding stool
Marchepied pliant
Tamborete dobrável

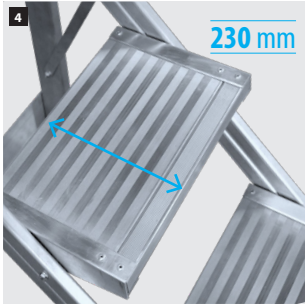

230 mm

4 Escalón súper-ancho de 230 mm de huella.
Super-wide step with 230 mm footprint.
Marche super large de 230 mm d'empreinte.
Degrau super largo de 230 mm de pegada.



5 Tapafinial de PVC con relieves antideslizantes.
PVC end cap with anti-slip reliefs.
Patin en PVC avec reliefs antidérapants.
Pé de PVC com relevos antiderrapantes.



Lock
SYSTEM

6 Sistema de bloqueo de seguridad en barandilla.
Safety locking system on safety railing.
Système de verrouillage en rampe de sécurité.
Sistema de bloqueio en corrimão de segurança.



REF 26 645 202



46 cm.

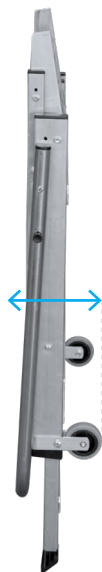

8 cm.



TABURETES PLEGABLES / FOLDABLE STOOLS / MARCHEPIEDS PLIABLES / TAMBORETES DOBRÁVELS

K-FOLD **Taburete plegable**
Folding stool
Marchepied pliant
Tamborete dobrável

RECAMBIOS / SPARE PARTS / PIÈCES DE RECHANGE/ PEÇAS DE REPOSIÇÃO

REF	DESCRIPCIÓN RECAMBIO / SPARE PARTS / PIÈCES DE RECHANGE/ PEÇAS DE REPOSIÇÃO
1 29 040 043	Juego de tapafinales PVC 64x25 mm : Tapafinal trasera 64x25 (2 u). Set of PVC end caps 64x25 mm : End cap 64x25 mm (2 u). Jeu de patins PVC 64x25 mm : Patin 64x25 (2 u). Conjunto de pés PVC 64x25 mm : Pé esquerda 64x25 mm (2 u).
2 29 040 007	Juego de tapas PE 64x25 mm : Tapa 64x25 mm (2 u). Set of PE plugs 64x25 mm : Plug 58x25 mm (2 u). Jeu de bouchons PE 64x25 mm : Bouchon PE 64x25 mm (2 u). Conjunto de tampas PE 64x25 mm : Tampa 64x25 mm (2 u).
3 29 040 013	Juego de tapas PE ø30 mm : Tapa ø30 mm (2 u). Set of PE plugs ø30 mm : Plug ø30 mm (2 u). Jeu de bouchons PE ø30 mm : Bouchon PE ø30 mm (2 u). Conjunto de tampas PE ø30 mm : Tampa ø30 mm (2 u).
4 29 040 088	Juego de tapafinales PVC 48x50 mm : Tapafinal izquierda (1 u) y tapafinal derecha (1 u). Set of PVC end caps 48x50 mm : Left end cap 48x50 mm (1 u) and right end cap 48x50 mm (1 u). Jeu de patins PVC 48x50 mm : Patin gauche (1 u) et patin droit (1 u). Conjunto de pés PVC 48x50 mm : Pé esquerda 48x50 mm (1 u) e pé direita 48x50 mm (1 u).
5 29 040 03#	Juego de tapas PE 33x20 mm : Tapa 33x20 mm (2 u). Set of PE plugs 33x20 mm : Plug 33x20 mm (2 u). Jeu de bouchons PE 33x20 mm : Bouchon 33x20 mm (2 u). Conjunto de tampas PE 33x20 mm : Tampa 33x20 mm (2 u).
6 29 060 011	Conjunto rueda ø80 mm para K-FOLD : Rueda ø80x24 goma gris (casquillo 6,25 R.4)(1 u), tornillo DIN 933 Fe-Zn M6x45 c/hex (1 u) y tuerca DIN 985 M6 Fe-Zn Autoseguro (1 u). Set of wheel ø80 mm for K-FOLD : Grey wheel of ø80x24 mm (bushing 6,25 R.4) (1 u), Fe-Zn screw DIN 933 M6x45 hex/h (1 u) and nut DIN 985 M6 Fe-Zn automatic safety (1 u). Jeu de roues ø80 mm pour K-FOLD : Roue ø80x24 avec gomme gris (douille 6,25 R.4) (1 u), vis Fe-Zn DIN 933 M6x45 t/hex (1 u) et vis DIN 985 M6 Fe-Zn sûreté automatique (1 u). Conjunto de roda ø80 mm para K-FOLD : Roda cinzento ø80X24 mm (casquilho 6,25 R.4) (1 u), parafusos Fe-Zn DIN 933 M6x45 c/hex (1 u) e porca DIN 985 M6 Fe-Zn segurança automática (1 u).

